



PDHonline Course M531 (2 PDH)

Motor and Drive System Basics

Instructor: Elie Tawil, P.E., LEED AP

2020

PDH Online | PDH Center

5272 Meadow Estates Drive
Fairfax, VA 22030-6658
Phone: 703-988-0088
www.PDHonline.com

An Approved Continuing Education Provider



Improving Motor and Drive System Performance:

A Sourcebook for Industry



U.S. Department of Energy
**Energy Efficiency
and Renewable Energy**

Bringing you a prosperous future where energy
is clean, abundant, reliable, and affordable

Section 1: Motor and Drive System Basics

Overview

Electric motors, taken together, make up the single largest end use of electricity in the United States. In industrial applications, electric motors account for roughly 60% of electricity consumption; in the process industries, electric motors account for more than 70% of electricity use. Electric motors provide efficient, reliable, long-lasting service, and most require comparatively little maintenance. Despite these advantages, however, they can be inefficient and costly to operate if they are not properly selected and maintained. Industrial plants can avoid unnecessary increases in energy consumption, maintenance, and costs, by selecting motors that are well suited to their applications and making sure that they are well maintained.

A System Approach

Cost-effective operation and maintenance of a motor and drive system requires attention not just to individual pieces of equipment but to the system as a whole. A systems approach analyzes both the supply and demand sides of the system and how they interact, essentially shifting the focus from individual components to total system performance. Operators can sometimes be so focused on the immediate demands of their equipment that they overlook the ways in which the system's parameters are affecting that equipment.

A common engineering approach is to break a system down into its basic components or modules, optimize the selection or design of those components, and then assemble the system. An advantage of this approach is that it simplifies problems. A disadvantage is that this approach ignores the interaction of the components. For example, sizing a motor so that it is larger than necessary—essentially giving it a safety factor—ensures that the motor is strong enough to meet the needs of the application. However, an oversized motor can create performance problems with the driven equipment, especially in turbomachinery such as fans or pumps. In certain circumstances, an oversized motor can compromise the reliability of both the components and the entire system.

In a component approach, the engineer employs a particular design condition to specify a component. In a systems approach, the engineer evaluates the entire system to determine how end-use requirements can be provided most effectively and efficiently. Focusing on systems means expanding possibilities, from looking for one piece of

equipment that can meet worst-case needs to evaluating whether components can be configured to maintain high performance over the entire range of operating conditions.

A basic premise of a systems approach is that industrial systems usually do not operate under one condition all the time. Motor and drive system loads often vary according to cyclical production demands, environmental conditions, changes in customer requirements, and so on. To optimize system performance, the engineer must configure the system to avoid inefficiencies and energy losses. For example, motors that typically run at more than one-half to full load usually operate much more efficiently than they do at less than one-half load or into their service factor. The service factor is a multiplier that indicates the percentage of horsepower (or other nameplate rating, such as torque) above full load at which a motor can operate without causing a failure under certain conditions. Common service factor values are 1.10 and 1.15. Other avoidable losses include waste heat and flow energy that dissipates without performing useful work.

For example, suppose that a motor-driven pump supplies water to several heat exchangers and has a flow requirement that the system piping and heat exchangers were designed to handle. The pump was specified according to the requirements of this flow condition. However, actual operating conditions can vary according to the season, the time of day, and the production rate. To handle the need for variable flow rates, the system is equipped with valves and bypass lines. This equipment can be useful if it is properly applied, but wasteful if it is not.

Similarly, many fan systems have variable air delivery requirements. A common practice is to size the fan so that it meets the highest expected load and use dampers to restrict airflow during periods of low demand. However, one of the least efficient methods of controlling flow is to use dampers. Consequently, although the system provides adequate airflow, the lack of a drive to control the motor's speed (and thus airflow) can cause system operating costs to be significantly higher than necessary.

In addition to increasing energy costs, an inefficient motor and drive system often increases maintenance costs. When systems do not operate efficiently, the stress on the system caused by energy losses must be dissipated by piping, structures, dampers, and valves. Additional system stresses can accelerate wear and create loads for which the system was not originally designed. For example, in a pumping system, excess flow energy must be dissipated across throttle valves or through bypass valves, or it must be absorbed

by the piping and support structure. As a result, all of this equipment can degrade more easily. Throttle and bypass valves can require seat repair, and piping and support structures can develop cracks and leak as a result of fatigue loads. Repairing or replacing this equipment can be costly.

In addition, inefficient system operation in an industrial plant can create poor working conditions, such as high levels of noise and excessive heat. High noise levels can be the result of flow noise, structural vibrations, or simply operating the equipment. Excessive noise can fatigue workers more quickly and thus reduce productivity. In addition, inefficient systems often add heat to the workplace. This added heat usually must be removed by the facility's heating, ventilating, and air-conditioning (HVAC) system, further increasing total operating costs.

Indications of Poor System Design

Taking a component-based approach to industrial system design and operation tends to increase facility costs and maintenance requirements and reduce reliability. However, the problems associated with a poorly designed system—high energy costs, the need for frequent maintenance, and poor system performance—can be corrected, as indicated below.

■ High Energy Costs

High energy costs can be the result of inefficient system design as well as inefficient motor operation. Not selecting or designing a proper motor and drive system for the application can also lead to power quality problems, such as voltage sags, harmonics, and low power factor.

■ Frequent Maintenance

Equipment that is not properly matched to the requirements of the application tends to need more maintenance. The primary causes of increased maintenance requirements are the added stresses on the system and the increased heat that accompanies inefficient operation. Ironically, system designers often specify oversized motor and drive and end-use equipment in order to improve reliability. An oversized motor might be more reliable, but it might also make other parts of the system less reliable. A more effective way of ensuring high reliability is to design a system and specify system components so that the system's operating efficiency is high over the full range of operating conditions.

■ Poor System Performance

Operating a motor and drive system that was not properly selected for its application can result in poor overall system performance. Poor system performance is a major cause of increases in maintenance and decreases in reliability. Common indications include abrupt or frequent system starts and stops, high noise levels, and hot work environments. In many material handling systems, the work-in-process moves roughly from one work station to the next. The banging that often accompanies sudden accelerations and decelerations is symptomatic of stress on the motor and drive system. The consequences of this stress can be more frequent maintenance and poor operating efficiency.

High noise levels are common in inefficient fluid systems. Since energy losses in fluid flow often dissipate as noise, systems with large flow losses tend to be loud. In addition, inefficient equipment operation often greatly increases the temperature of the workspace, especially if the added heat load was not included in the design specifications for the HVAC system.

Types of Electric Motors

To ensure that motors are applied properly, it is essential to understand the various types of motors and their operating characteristics. Electric motors fall into two classes, based on the power supply: **alternating current (ac)** or **direct current (dc)**. The most common types of industrial motors are shown in Figure 1.

Alternating current (ac) motors can be single-phase or polyphase. In terms of quantity, single-phase motors are the most common type, mainly because many small motors are used for residential and commercial applications in which single-phase power is readily available. However, several operating constraints on these motors limit their widespread use in industrial applications. Integral single-phase

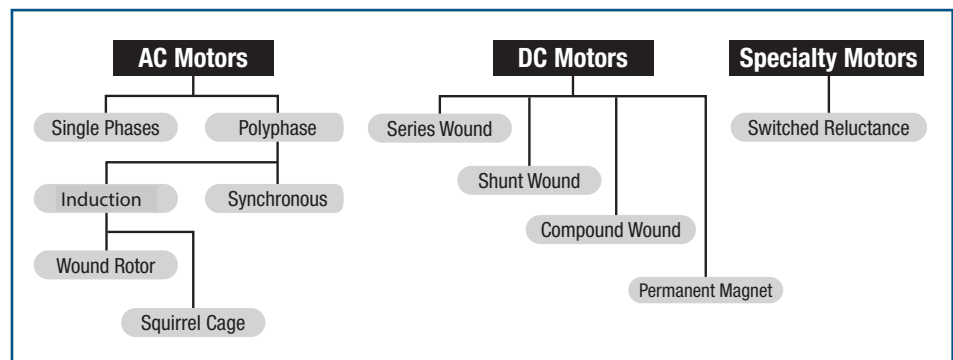

Figure 1. Types of motors

induction motors tend to pull large starting currents relative to the motor's size. In general, they operate less efficiently than three-phase motors of comparable size, and are not available in larger sizes.

In contrast, polyphase motors are used widely in industrial applications. They consume more than half of all the electricity used in industry. Polyphase motors can be found in almost every industrial process, and they often operate continuously to support production processes. These motors can achieve high efficiencies with favorable torque and current characteristics. The effectiveness and low cost of three-phase motors are major reasons why three-phase power is used so widely in industry. In terms of energy consumption and efficiency improvement opportunities, three-phase motor systems predominate. Therefore, they are the main focus of this sourcebook.

■ Direct Current Motors

Direct current (dc) power was central to Thomas Edison's vision of how electricity should be supplied. Because of their competitive advantages, however, ac power and ac motors soon became the industry favorite. Despite the predominance of three-phase ac motors, dc power has advantages in certain industrial applications and is still widely used.

The advantages of dc motors include excellent speed control and the ability to provide high torque at low speeds. However, a majority of dc motors use brushes to transfer electrical power to the motor **armature**. Brush assemblies not only require a larger motor, they can also increase maintenance requirements. As brushes wear, they create a housekeeping problem by generating carbon dust. Brushes are also sensitive to contamination, especially in machines that contain silicone materials, and they must be replaced periodically.

Since electric power is supplied as alternating current, additional equipment that generates dc power, such as motor generator sets or rectifier systems, is needed to run dc machines. Because batteries supply dc current, dc motors have an advantage in applications in which the motor is supplied by a dc bus as part of an uninterruptible power system. Although these applications are somewhat specialized, they could increase as industry becomes more sensitive to power quality problems and more aware of the high cost of interruptions in production.

There are four principal classes of dc motors: series wound, shunt wound, compound wound, and permanent magnet. Series wound, shunt wound, and compound wound motors all require brushes to supply current to the stator. The differences between these motors are based on how the stator (field frame) and the rotor (armature) are connected.

Series Motor. In a series motor, as the name implies, the stator and the rotor are connected in series and the same current passes through both. In this configuration, torque increases in proportion to the square of the increase in current. This relationship is true until the magnetic strength of the motor is reached, a condition known as *saturation*. Beyond saturation, any load increase is directly proportional to an increase in current.

Shunt Motor. In a shunt motor, the rotor and the stator circuits are connected in parallel. The torque and speed of these motors is relatively independent of the load. Consequently, adjusting the stator circuit resistance controls the strength of the magnetic field, and this permits relatively accurate control of the motor speed.

Compound Motor. A compound motor is a combination of a series and a shunt wound motor. It has two basic circuit branches; one circuit wraps around the stator, and the other is a series circuit that includes both the stator and the rotor. A key operating characteristic of this type of motor is that it can handle sudden increases in loads without a great change in speed.

Permanent Magnet. Permanent magnet (PM) motors rely on inherently magnetic materials—such as alloys of cobalt, nickel, iron, and titanium—to create a magnetic field. PM motors can be up to 600 hp in size. They can be constructed in several different ways, and some versions operate with ac power. However, most industrial PM motors are brushless dc types. An electronically commutated motor (ECM) is a type of brushless dc motor having speed and torque control. ECMs can use single-phase ac input power and convert it into three-phase operation. And they use electromagnetic force (EMF) sensing to determine rotor position and perform the commutation function. Because of their design, ECMs do not exhibit the brush wear and noise associated with typical dc motors.

PM motors have certain performance advantages over ac induction motors, especially in applications with wide variations in load and speed. PM motors can maintain relatively high efficiencies at low motor loads and, like other dc motors, they can provide high torque at low motor speeds. Since they do not require brushes, using PM motors

Section 1: Motor and Drive System Basics

avoids many of the operating and maintenance problems normally associated with dc motors. Advances in PM motor technology have made this type competitive with the more commonly used induction motor/**variable frequency drive** combination, in many applications. A drawback of PM motors is their tendency to accumulate magnetic contaminants, even when the motor is idle.

■ Alternating Current Motors

Alternating current (ac) motors are the most widely used in industry. Industry's preference for ac motors springs from their simplicity, low cost, and efficiency. There are two primary types of ac motors: induction (also referred to as asynchronous) and synchronous. With the exception of wound rotor motors that have slip rings, the rotors of induction motors are not physically connected to any external circuits; instead, the excitation current is induced by a magnetic field. In synchronous rotors, the excitation current is fed directly to the rotor by means of brushes or slip rings. Induction motors are used widely because of their simple design, rugged construction, relatively low cost, and characteristically long operating life. Synchronous motors, on the other hand, have some useful advantages and are used in more specialized applications.

In both types of motors, the stator circuit creates a magnetic field that rotates at a **synchronous speed**. This speed depends on the number of **poles** and the **frequency** of the electricity supply, and it is determined by the following equation:

$$\text{Synchronous speed} = \frac{120 \times \text{frequency (Hz)}}{\text{number of poles}}$$

For example, in a 60 Hz system, the stator field in a two-pole motor rotates at 3600 rpm, the field in a four-pole motor rotates at 1800 rpm, and the field in a six-pole motor rotates at 1200 rpm.

An important operating difference between induction motors and synchronous motors is that induction motors operate at somewhat less than synchronous speed. The difference between the actual speed and synchronous speed is known as slip. Synchronous motors operate without slip at synchronous speed.

Induction Motors. Induction motors include squirrel cage and wound rotor types. Induction motors rely on a magnetic field to transfer electromagnetic energy to the rotor. The induced currents in the rotor create a magnetic field that

interacts with the stator field. The speed of the rotor's magnetic field is slightly less than that of the stator (this difference is the slip). As the load on the motor increases, the slip also increases. A typical induction motor is shown in Figure 2.

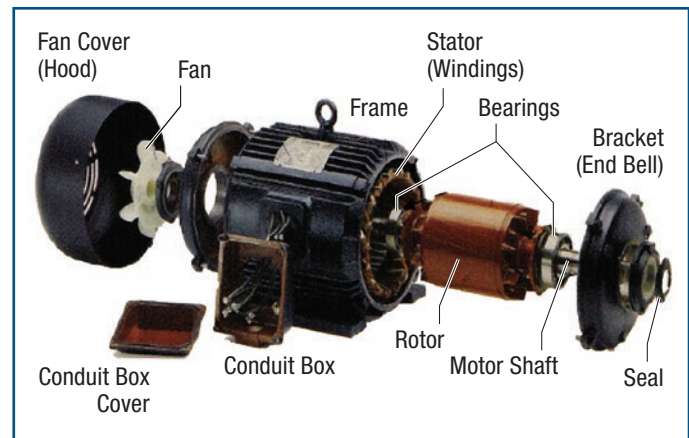

Figure 2. Induction motor

Courtesy of Leeson Electric Corporation

Squirrel Cage Motors. The most common type of industrial motor is the squirrel cage induction motor. The name derives from the similarity between the rotor and the type of wire wheel commonly found in pet cages at the time this motor was first developed (see Figure 3). Rotor **bars** are either welded or cast to two circular end rings, forming a circuit with very little resistance.

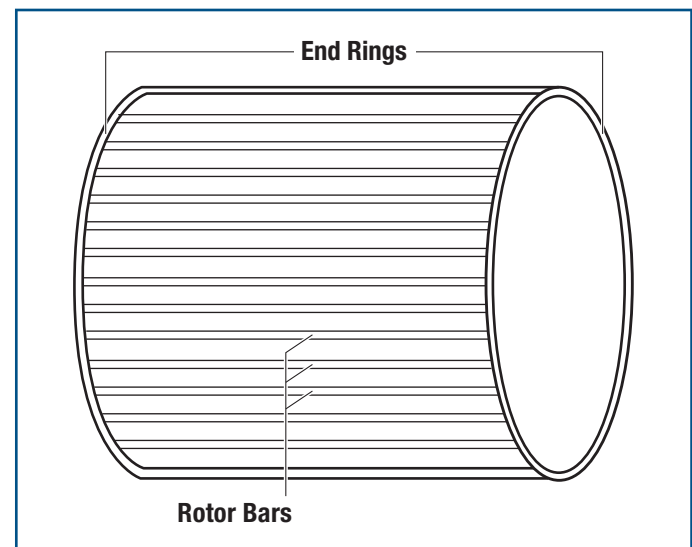

Figure 3. Squirrel cage rotor

Advantages of this type of motor include the following:

- Low cost
- Low maintenance
- High reliability
- A fairly wide range of torque and slip characteristics.

Since squirrel cage induction motors can be designed and built to have a relatively wide range of torque and slip characteristics, NEMA has developed a set of classifications for these motors. These classifications help engineers and designers select the right motors for applications that require certain starting torques, operating torques, and slip rates. For more on these motor classifications, see *Efficiency Opportunity No. 4, Selecting the Right Motor*, in Section 2 of this sourcebook.

Wound Rotor Motors. Another type of induction motor is the wound rotor. In this type, either bars are inserted into the rotor or wires are wound into slots in the rotor. In wound rotors, current is induced in the rotor and the resistance of the rotor circuit is varied by adding or removing external resistance to control torque and speed. An important operating characteristic of these motors is the ability to adjust speed and torque characteristics by controlling the amount of resistance in the rotor circuit.

Characteristics of this type of motor include the following:

- Excellent speed control
- High starting torque
- Low starting current
- Ability to handle high-**inertia** loads (induction motor slip losses would be too large and could overheat rotors)
- Ability to handle frequent starts and stops
- Ability to operate at reduced speeds for long periods.

Synchronous Motors. These motors, as their name implies, operate at the same speed as the rotating magnetic field. Although they are more expensive to purchase and maintain, they can be 1% to 2% more efficient—depending on motor size—than induction motors. They can also add a leading power factor component to a distribution system, which makes them attractive to many industrial facilities. In fact, synchronous motors are occasionally operated without a load, as synchronous condensers, just to increase a facility's power factor.

In industrial synchronous motors, an external supply of dc power is usually supplied to the rotor by a set of slip rings or brushes. In newer models, brushless excitation systems and permanent magnet generators are built into the rotor. Since the dc current does not change the polarity, the rotor needs a separate squirrel cage winding during starts. But

once the rotor approaches operating speed, the squirrel cage winding becomes inoperative; as the dc current is applied, the rotor speed is pulled into synchronicity with the rotating magnetic field created by the stator.

Switched Reluctance Motors. Switched reluctance (SR) motors have several performance, efficiency, and cost advantages that should encourage their use in an increasing number of applications. SR motors do not have magnets or rotor **windings**. Their simple, rugged design also provides higher reliability. Important advantages of SR motors include exceptional feedback and flexibility in speed and torque control.

SR motors operate much like an electromagnetic **coil**. The stator contains poles that, when energized, create a magnetic field that pulls the nearest pole on the rotor toward it. Consequently, the performance of SR motors is largely a function of the power electronics that control the sequencing of pole energizations. SR motors have characteristically high power-to-weight ratios and are well suited for vehicle applications. Their torque and speed control characteristics also make them suitable for pump and fan applications in which power is highly sensitive to operating speed. In the past, the disadvantages of SR motors included torque ripple (pole-to-pole variations in torque) and higher operating noise; however, improvements have been made in these areas.

SR motor technology was initially developed in the 19th century, but limitations in power electronics technology made this type of motor impractical. Later developments in power electronics improved their performance and lowered their costs, increasing their applicability. However, the cost of the power modules often offsets the lower cost of the SR motor itself. The modules are relatively specialized, often generating four-phase power.

Improvements in power electronics have made both PM and SR motors and similar systems much more suitable for many applications. Despite the many advantages of these motor systems, the most common type of industrial motor is still the squirrel cage induction type. Since motors are indispensable to plant operations, facilities tend to resist using a new motor technology if the current system is performing adequately. Adopting better operating practices or incorporating better controls into existing induction motor systems incurs less risk and can result in the same levels of efficiency and performance that new motor technologies exhibit.

Motor Operating Characteristics

The most important motor operating characteristics are horsepower, operating speed (measured in revolutions per minute [rpm]), and torque. These are related by the following equation:

$$\text{Hp} = \frac{\text{torque (ft-lb)} \times \text{rpm}}{5,252}$$

Motor performance depends on how well these operating characteristics match the load. The load on a motor is not always constant, and the response of the motor to changes in load is a fundamental factor in selecting the right motor for an application. For more on this, see *Efficiency Opportunity No. 4, Selecting the Right Motor*, in Section 2 of this sourcebook.

■ Voltages

The motor voltage must match the rated system supply voltage. A mismatch between the motor voltage and the system voltage can result in severe operating problems and, in some cases, immediate failure. However, this type of problem is not common. Operating a motor when the system voltage varies significantly from its rated level is a more critical concern. And, problems like these are often the result of a distribution system problem, such as **three-phase** voltage unbalance, voltage outages, sags, **surges**, and over or undervoltage.

Motor performance is significantly affected when a motor operates at voltages $\pm 10\%$ or more from its rated voltage. See *Efficiency Opportunity No. 6, Addressing In-Plant Electrical Distribution and Power Quality Issues*, in Section 2 of this sourcebook. A facility that experiences wide swings in voltage will probably have an abundance of power quality problems, including poor motor operation. If that is the case, the facility's distribution system should be reviewed.

■ Horsepower

The horsepower rating of the motor should be able to support the power requirements of the load without being oversized. In other words, the motor's horsepower should ensure that the motor not operate below 40% of full load for long periods (see Figure 4). Motor torque and speed are important additional considerations in determining a motor's ability to operate effectively and efficiently. The responsiveness of the motor in starting and operating is critical and should be considered concurrently with its horsepower.

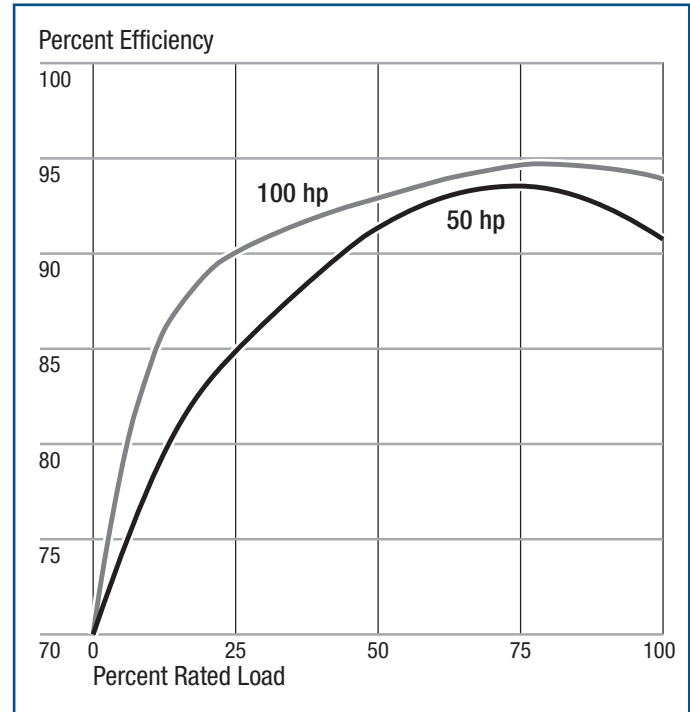

Figure 4. Typical motor part load efficiency curve
(Adapted from A. Bonnet, *IEEE Trans.* 36:1, Fig. 26, Jan. 2000)

Engineers should be careful not to oversize a motor just to satisfy a speed or torque requirement. Oversized motors tend to incur higher purchase, maintenance, and operating costs (including costs for power factor correction). A systems approach to motor selection is an effective way of ensuring adequate, cost-effective operation.

■ Speed

The speed of an electric motor is an important element that depends on many factors. The operating speed of a dc motor depends on the type of motor, the strength of the magnetic field, and the load. The operating speed of an ac motor depends on the rotor type, the number of poles, the frequency of the power supply, and slip characteristics. Synchronous ac motors operate at the speed of the rotating magnetic field; most induction motors operate within 1% to 3% of this speed, depending on the motor's slip characteristics.

Common synchronous speeds are 3600, 1800, 1200, 900, and 600 rpm. Many applications require speeds different from these, however, so motors are usually combined with various types of speed adjustment devices. These devices include gears, belts, eddy-current couplings, hydraulic couplings, variable frequency drives (VFDs), etc. Motors can also operate at multiple speeds by using separate

windings within the same motor or by using a single winding with an external switch that changes the number of poles.

An important consideration is whether the speed must be constant or variable. In constant speed applications, gears or belts can provide fixed speed ratios between the motor and the driven equipment. Variable speed applications can be served by multiple-speed motors or drive systems with adjustable speed ratios.

Adjustable Speed Motors. Many applications that are currently served by constant speed motors are well suited for variable speed motors. For example, in many pumping system and fan system applications, flow is controlled by using restrictive devices, such as throttle valves or dampers, or bypass methods. Although these flow control methods have advantages, speed control is often a more efficient and cost-effective option for many systems.

Similarly, in many material handling systems, adjustable speed drives can increase system efficiency and improve system reliability. For example, in many conveyor systems, lines are controlled by energizing and de-energizing a series of motors. These frequent starts and shutdowns are tough on motors and line components because of repeated stresses from starting currents and acceleration and deceleration of mechanical components. Using variable speed drives can smooth out line motion for more efficient and effective operation.

Some motors have inherent speed control capabilities. For example, dc motors have excellent speed and torque control characteristics and are often used when high torque at low speeds is required. The speed adjustments of dc motors can be as much as 20:1, and they can operate at 5% to 7% of the motor's base speed (some can even operate at 0 rpm). Some ac motors can also be used in speed adjustment situations. Wound rotor motors can have speed ratios of as much as 20:1 by changing the resistance in the rotor circuit.

Another common method of controlling speed is to use induction motors combined with VFDs. Induction motors are widely used in industrial applications because of their inherent advantages in terms of cost, reliability, availability, and low maintenance requirements. Mechanics and operators are usually familiar with these motors, which facilitate repair and maintenance tasks.

Combining an in-service motor with a VFD provides facilities with an effective speed control technology that does not require the use of a different type of motor. However, not all in-service induction motors can be combined with a VFD; engineers should evaluate motors case-by-case to see if such combinations are feasible. Misapplying VFDs to in-service motors can quickly cause motor failures. Moreover,

some motor-driven machines have speed-dependent lubrication systems, and these must be considered in any assessment associated with changes in speed.

Induction motors with VFDs are increasingly being used in applications that once featured dc motors. Although dc motors still have some operating advantages in low-speed, high-torque applications, the added complexity associated with operating and maintaining a dc motor system is an important factor behind the increasing numbers of induction motor/VFD systems. See *Efficiency Opportunity No. 5, Using Variable Frequency Drives*, in Section 2 of the sourcebook.

Another speed control option is to use an ac motor with an intermediate drive device that allows adjustable speed ratios. Eddy current and hydraulic couplings allow varying degrees of slip between the driver and the driven equipment to achieve the desired output speed. In eddy current couplings, the slip is controlled by adjusting the strength of the magnetic field in the coupling. In hydraulic couplings, a pump similar to the one used in automobile transmissions allows fluid to recirculate rather than perform mechanical work. Drawbacks to these devices include relatively low efficiency compared to that of other speed control devices, and high maintenance costs.

Multiple-Speed Motors. Multiple-speed motors are another speed control option. Ac motors can be built to operate at different, discrete speeds using two principal approaches. First, they can be constructed with multiple windings, one for each speed. These motors are usually two-speed, but they can be built to run at three or four speeds. Motors with different sets of windings are used in many cooling system applications so they can operate at different speeds. In general, these motors are less efficient because of the effects of the additional windings. Second, in many multiple-speed motors, a single winding can be controlled with a starter that allows the winding to be reconfigured into different speeds (with a ratio of only 2:1).

A principal advantage of multiple-speed motors is their ability to operate at different speeds using a compact motor/drive assembly. Floor space is valuable, and multiple-speed motors are space savers. Alternative speed control options often take up space savers, and require additional maintenance.

■ Torque

Torque is the rotational force that a motor applies to its driven equipment, and a fundamental factor in motor performance. The torque capacity of a motor depends on many design characteristics.

Section 1: Motor and Drive System Basics

Figure 5 shows a torque curve for a typical induction motor. Starting torque is the instantaneous torque developed by the motor when it is first energized, and it is the same torque generated during locked rotor and stall conditions. This torque value is important because, even if a motor has sufficient horsepower, it could overheat before reaching operating speed if it cannot accelerate the load from rest.

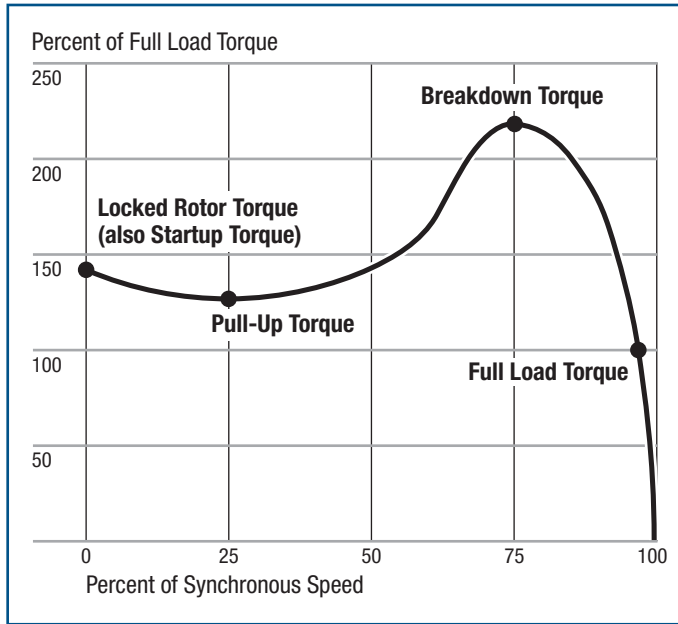

Figure 5. Typical motor speed torque curve

Pull-up torque is the minimum torque that the electric motor develops when it runs from zero to full-load speed (before it reaches the breakdown torque point). Full-load torque is the torque produced by the motor at rated horsepower. Motors sometimes exceed full-load torque during changes in the load; however, sustained operation above full load can reduce the operating life of a motor. Breakdown torque is the maximum torque that the motor can generate without an abrupt drop in speed. If the load exceeds this torque, the motor will stall, causing it to rapidly overheat and risking insulation failure if it is not properly protected.

Load Characteristics

There are four basic types of loads:

- Variable torque
- Constant torque
- Constant horsepower
- Cyclic loads.

The most common type of load has variable torque characteristics, in which horsepower and torque are proportional to speed. For example, in centrifugal pumps and fans, torque varies according to the square of speed.

In a constant torque load, the torque is independent of speed. Common applications include conveyor systems, hoists, and cranes. For example, conveying a 500-pound load along an assembly line requires the same amount of torque whether it is moving at a constant speed of 5 feet per minute or 10 feet per minute. Although horsepower varies according to speed, torque is constant.

In a constant horsepower load, the torque increases with decreasing speed and vice versa. A good example of this type of load is a winding machine in which the torque increases as the roll thickness builds up but the rotational speed slows down. Machine tools such as lathes and cutting machines display these operating characteristics.

A cyclic load is one in which the torque changes significantly within a cycle or over a series of cycles. An example is an oil well pump; in this application, the downstroke of the pump piston requires much less force than the upstroke. Also, some air compressors and refrigeration system compressors have cyclic load characteristics; they tend to shut down and start up in response to system pressures.

Load inertia refers to the resistance of the load to changes in speed. Applications that have high load inertia tend to require high starting torques. Load inertia is commonly referred to by the term Wk^2 . Examples of loads with high inertia are large fans and machines with flywheels, such as punch presses. The ratio of load inertia to motor torque has a strong effect on the responsiveness of the motor system to changes in the load.

Affinity Laws

$$\text{Flow}_{\text{final}} = \text{flow}_{\text{initial}} \left(\frac{\text{rpm}_{\text{final}}}{\text{rpm}_{\text{initial}}} \right)$$

$$\text{Pressure}_{\text{final}} = \text{pressure}_{\text{initial}} \left(\frac{\text{rpm}_{\text{final}}}{\text{rpm}_{\text{initial}}} \right)^2$$

$$\text{Power}_{\text{final}} = \text{power}_{\text{initial}} \left(\frac{\text{rpm}_{\text{final}}}{\text{rpm}_{\text{initial}}} \right)^3$$

Matching Motor and Drives to Their Applications

To select the proper motor for a particular application, the engineer needs to consider the basic requirements of the service. These include the load profile, environmental conditions, the importance of operating flexibility, and reliability requirements. About 60% of the energy consumed by industrial motor-driven applications is used to drive pumps, fans, and compressors. Within these applications, centrifugal pumps and fans share some common relationships between speed (commonly measured in rpm), flow, pressure, and power; these are known as affinity laws (see sidebar on page 10).

One important implication of these laws is that power consumption is highly sensitive to operating speed. Increasing the speed of a fan or a pump requires a relatively large increase in the power required to drive it. For example, doubling the speed of the machine requires eight times more power. Similarly, decreasing the speed of a fan or pump removes a significant load from the motor.

The pump performance curve shown in Figure 6 illustrates the relationship between power and speed. The operating point is the intersection between the system curve and the pump's performance curve. To achieve the desired operating flow with a fixed-speed pump, a throttle valve is used to control flow. The throttle valve increases the pressure in the pipe and takes pump performance to point A on the original performance curve. Opening the throttle valve drops the pressure.

Note how the amount of power that the pump uses is dramatically reduced by slowing its rotational speed. Reducing the pump's speed with an **adjustable speed**

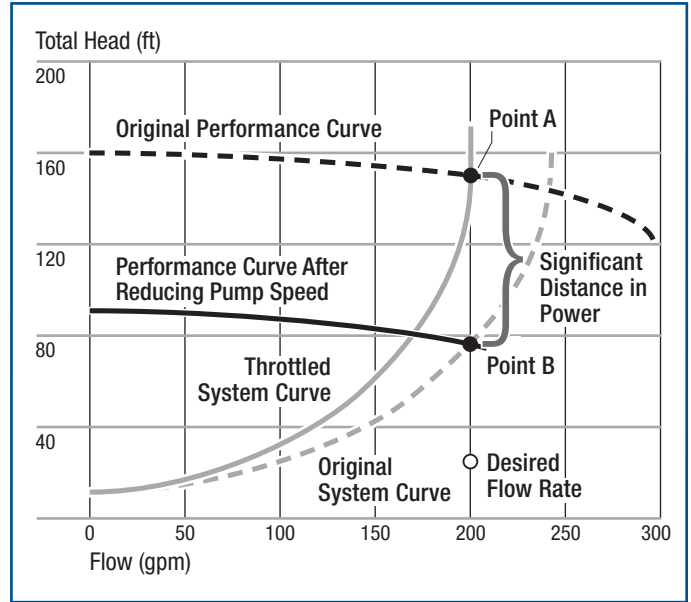

Figure 6. Effect of speed reduction on the power used by a pump

drive (ASD) takes the pump to operating point B. Although operating point B provides the same desired flow rate, it does so with much less horsepower. At point B, the pump operates much more efficiently, thus saving energy. There is no longer a large pressure drop across the throttle valve, so maintenance requirements, system noise, and system vibration are reduced. Additional examples of this relationship are shown in Figures 7 and 8.

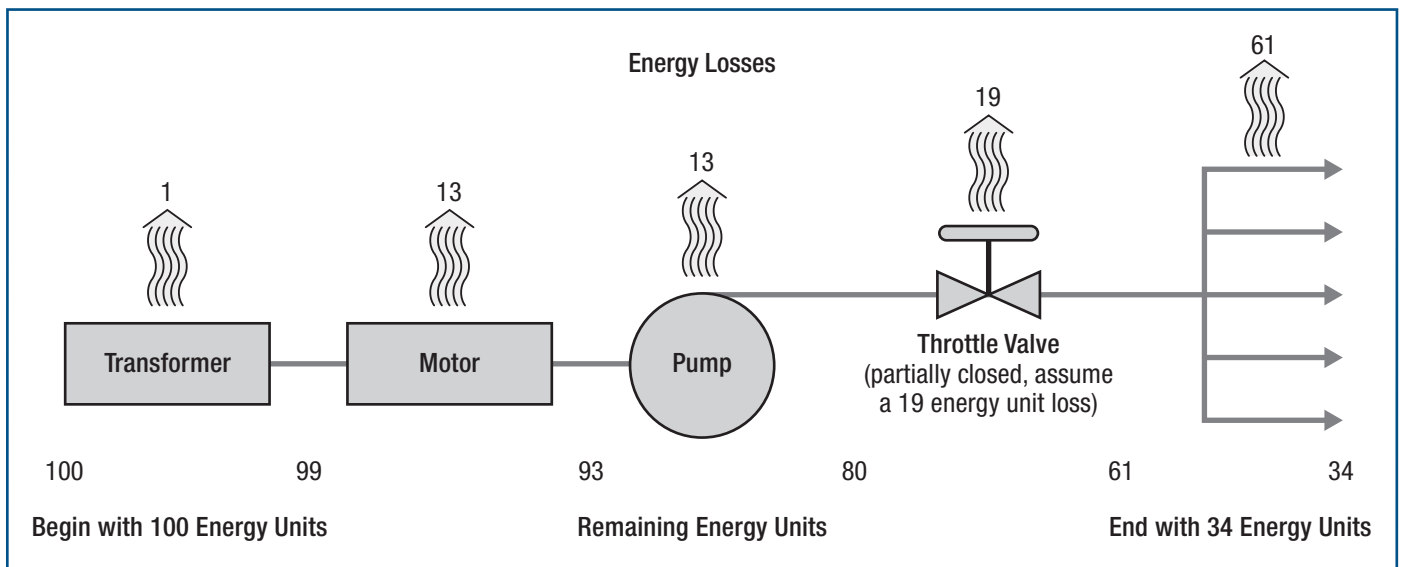

Figure 7. Energy losses in a pump system when a throttle valve controls flow

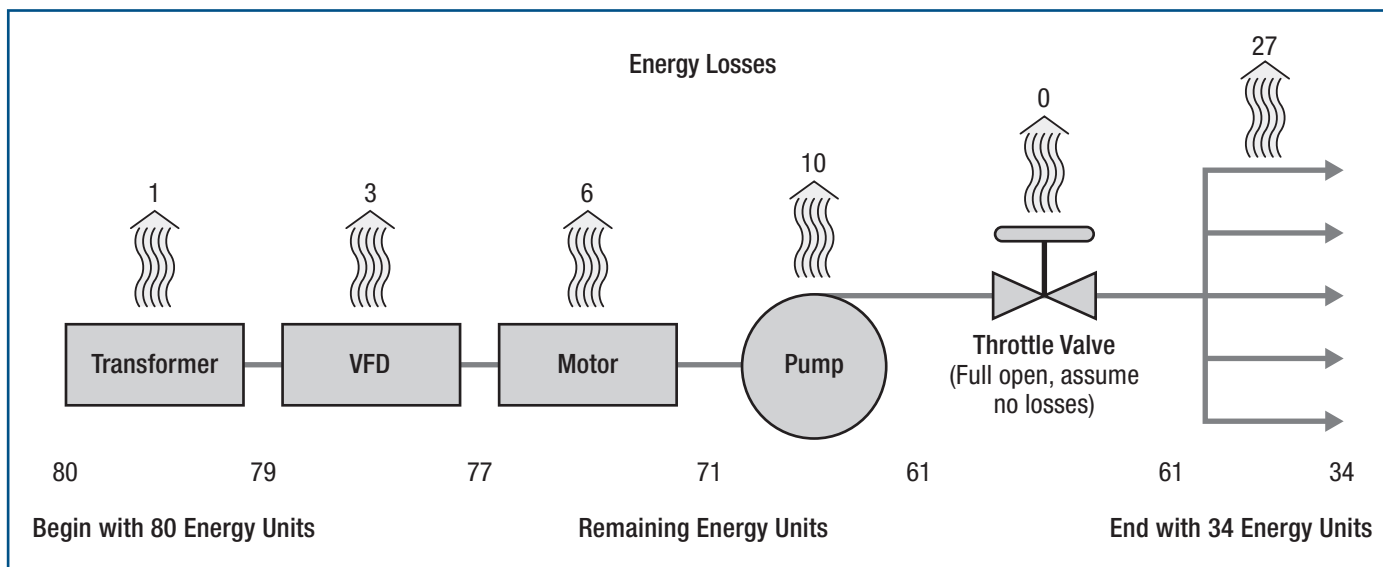

Figure 8. Energy losses in a pump system when an adjustable speed drive controls flow

Replacing a control valve with an ASD can increase system efficiency and provide significant energy savings. Note that in Figure 7, 100 energy units are supplied to the system; however, in Figure 8, the system does the same work with only 80 energy units. With the ASD, much less energy is lost across the throttle valve because the pump generates less flow.

■ Pumps

Centrifugal pumps are the type most commonly used, primarily because they are low in cost, simple to operate, reliable, and easy to maintain. In addition, they have relatively long operating lives.

System designers and engineers need to understand specific system operating conditions to size a centrifugal pump correctly. Many engineers tend to be conservative in estimating system requirements, and they often increase the size of the centrifugal pump and motor to accommodate design uncertainties, potential capacity expansions, and system fouling. However, this approach often leads to oversized pump/motor assemblies. Oversizing can increase operating costs as a result of increased energy and maintenance requirements and reduce system reliability because of added stresses on the system.

Pumping systems also frequently operate inefficiently because of poor flow control practices. Flow control options include throttle valves, bypass valves, multiple-speed pumps, multiple pump configurations, and pumps coupled to ASDs. Each flow control method has advantages and

drawbacks, depending on the particular application. When they are incorporated properly into a system, these methods provide adequate and efficient flow control. However, improper design or use can increase system costs significantly.

ASDs help to match the flow energy delivered to the system to the system's actual need. In pumping systems, VFDs are by far the most commonly used adjustable speed option. Reducing the pump speed proportionally reduces the flow while exponentially reducing the power requirement. Although installing VFDs can result in substantial energy savings, they are not suitable for all applications, particularly those in which pumps operate against high static (or elevation) head.

A useful tool for evaluating potential pumping system improvements is the Pumping System Assessment Tool (PSAT). Developed with the support of the U.S. Department of Energy Industrial Technologies Program (ITP) and available at no charge to users, the PSAT software helps the user evaluate pumping systems in order to determine the best improvement opportunities. A screening process identifies pump applications that are worth investigating further, and PSAT prompts the user to acquire data for further analysis. For more information on the PSAT and on properly matching pumps to system requirements, see *Improving Pumping System Performance: A Sourcebook for Industry*, which is available on the ITP Web site at www.eere.energy.gov/industry/bestpractices.

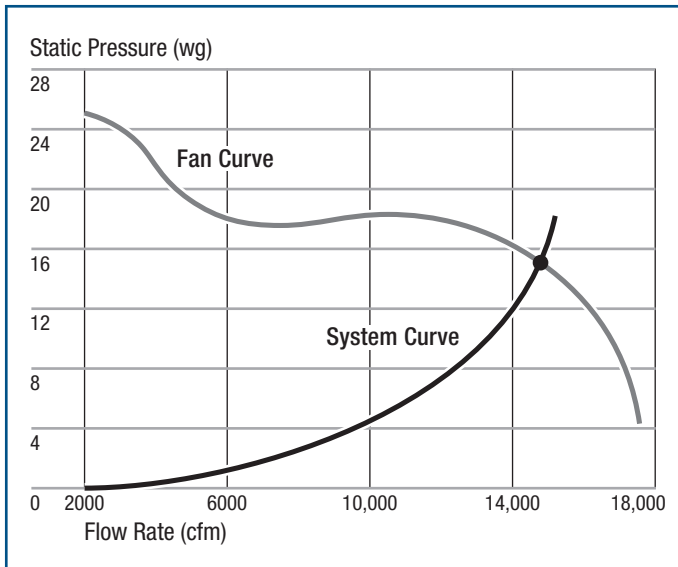

Figure 9. Typical fan and system curves

■ Fans

Fan performance curves (Figure 9) show that flow varies with pressure. Fans can be grouped into two fundamental classifications, based on the way that they impart flow energy to the airstream: axial fans and centrifugal fans.

Axial fans move air along the axis of a fan, much like a propeller. Centrifugal fans use a rotating impeller to accelerate air outward. This acceleration increases the kinetic energy of the airstream, which translates into an increase in pressure. These differences have several implications with respect to motors. Axial fans usually operate at higher speeds and, in some cases, they are directly coupled to the motor. Centrifugal fans tend to be heavier, and they often have high load inertia. This high load inertia can affect a plant's electrical distribution system, especially when the fans are started. However, many large fans can be equipped with suitable soft-start devices that avoid the stresses of across-the-line starts.

Most fans are driven by induction motors that operate at 3600, 1800, and 1200 rpm. Since these motor speeds are usually too high for direct drives, belt drives are usually used to establish the desired fan speed. An important exception to this guideline is vaneaxial fans. These fans are compact, efficient, and usually equipped with small fan blades to minimize the stresses caused by high rotating speeds.

Fan system designers also tend to be conservative, often specifying a larger fan than the system requires. However, oversized fans increase operating costs and can cause problems that are similar to those caused by oversized pumps. Oversized fans are often noisier than they should be, and they also require more maintenance.

Because required airflow rates often change according to the temperature, production level, occupancy, and boiler load, fans frequently experience varying **demand**. Although alternative flow control measures, such as dampers and inlet vanes, can be effective, often the most efficient option is to use a speed-control mechanism, such as a VFD, to adjust the fan's output. VFDs often have inherent soft-start capabilities that can limit starting currents. More information on fan systems can be found in *Improving Fan System Performance: A Sourcebook for Industry*, which is available on the ITP Web site at www.eere.energy.gov/industry/bestpractices.

A useful tool for evaluating potential fan system improvements is the Fan System Assessment Tool (FSAT). Developed with the support of ITP and available for download on the ITP Web site, FSAT software helps the user evaluate fan systems in order to determine the best improvement opportunities. A screening process identifies fan applications that are worth investigating further, and then prompts the user to acquire data for additional analysis. More information on FSAT and fan systems can be found in *Improving Fan System Performance: A Sourcebook for Industry*.

In other types of equipment—such as air compressors, positive displacement pumps, and positive displacement blowers—the relationship between flow and power is different from that of pumps and fans. Some energy-saving measures that are useful with certain centrifugal pump and fan systems, such as ASDs, can also save energy with these other systems. However, this is true only in certain applications, such as rotary screw compressors with variable loads. In addition, many common design and operating practices tend to reduce system efficiencies, particularly with respect to compressed air systems.

■ Air Compressors

Compressed air is important to most industrial facilities. It is used for such applications as driving hand tools, supplying pneumatic control systems, applying paints and coatings, and cleaning and drying parts. There are two principal types of air compressors: positive displacement and dynamic. Positive displacement compressors are more commonly used than dynamic ones.

Electric motors are widely available, and they provide power to compressors economically, reliably, and efficiently. Most compressors make use of standard polyphase induction motors; however, in some cases, motors with a higher service factor are used. In certain cases, the engineer can specify an energy-efficient or premium efficiency motor when a plant is purchasing a

compressor or replacement motor. The incremental cost of a premium efficiency motor is usually recovered in a very short time because of the resulting energy savings.

When replacing a standard motor with a premium efficiency one, it is important to pay careful attention to performance parameters such as full-load speed and torque. The replacement motor's performance should be as close as possible to that of the original motor. When replacing a drive motor in a compressor that uses a VFD as part of the control system, make sure the motor is designed to be used with **inverters**.

For most compressed air systems, demand varies widely from day to day. Changes in shifts and production levels, as well as downtime on nights and weekends, can create highly variable load duty cycles. Accommodating these wide fluctuations in demand is a principal challenge of compressed air system design.

The rotary screw air compressor is the type most widely used. Using VFD options to control output is becoming more common; however, most control systems still change flow demand by either starting and stopping the air compressor, using a load/unload mechanism, throttling the input, employing a variable displacement device, or using some other means of operating the compressor at part-load. A load/unload control strategy uses a valve or some other pressure-relieving device to reduce the load on the compressor so that it continues to operate.

These output control options for motor and drive systems can result in frequent starts and shutdowns and motors operating at low loads. Frequently starting and stopping large ac motors can result in power quality problems for the electrical distribution system and can cause motors to run at high temperatures. In addition, part-load operation of a motor usually results in a low power factor, which, if not corrected, can lead to power factor penalties. A variable displacement control strategy changes the output of the compressor by controlling the displacement volume. For more information on compressed air applications, see *Improving Compressed Air System Performance: A Sourcebook for Industry*, which is available on the ITP Web site at www.eere.energy.gov/industry/bestpractices.

A useful tool for assessing improvement opportunities in compressed air systems is AIRMaster+. This software tool was developed to help users simulate existing system operation and test potential modifications. AirMaster+

provides comprehensive information on assessing compressed air systems, including modeling existing and future system upgrades, and evaluating the savings and effectiveness of energy efficiency measures. By evaluating different operating schedules and control strategies, AIRMaster+ can help you determine how best to improve a compressed air system. AIRMaster+ is available for download on the ITP Web site.

■ Other Applications

Motors and drives are also used in a wide range of material handling and material processing services. These applications often have unique load characteristics, so they are somewhat difficult to describe in general terms. For example, material processing loads largely depend on the nature of the material being moved, mixed, chopped, or sifted. Also, these applications may be either batch-type or continuous, and operating priorities vary widely in each of those two categories.

Despite all of these differences, using a systems approach in designing, operating, and modifying motor and drive systems tends to reduce operating costs and increase system reliability. This approach stresses the importance of evaluating how different system components interact and how different control or sizing options can keep the components operating efficiently. One place to start is to evaluate the load duty cycle of system components.

Load Duty Cycles

The term *load duty* cycle refers to the amount of time that equipment operates at various loads relative to its rated capacity. An example of a load duty cycle is shown in Figure 10. Since motors are often specified according to worst-case operating conditions, applications in which normal operating loads are much smaller than the worst-case load often force the motor to operate at part-load much of the time. The load duty cycles for such motors would show a peak number of operating hours at low load levels.

This problem is actually relatively common. *The United States Industrial Electric Motor Systems Market Opportunities Assessment*, sponsored by ITP, found that more than 40% of the motors in industrial applications operate at or below 40% of their load rating. The consequences of operating a motor at these load levels include poor power factor and low efficiency.

When motors operate frequently at low loads and over a wide range of conditions, there are often many excellent opportunities to optimize the entire system, save energy, and improve reliability by making various improvements. Improvement opportunities can include replacing the motor with one of a more appropriate size or type, or installing a speed-adjusting device (or both).

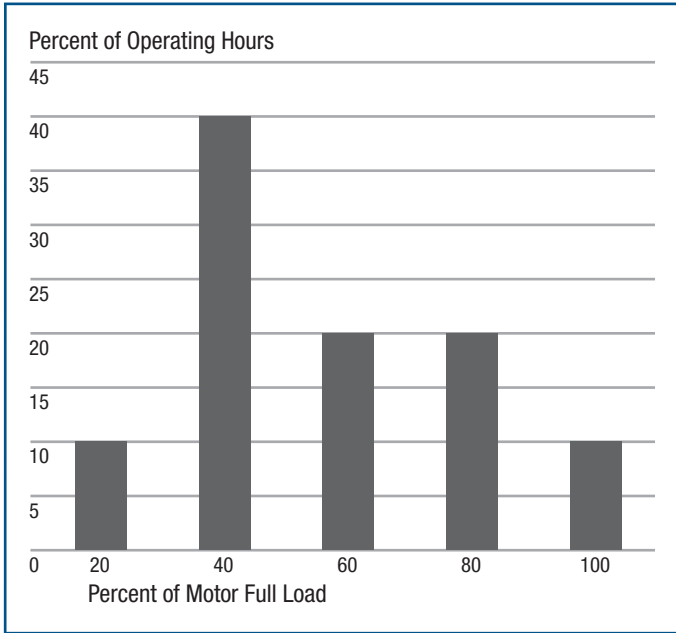

Figure 10. Load duty cycle – Example 1

In considering whether to downsize a motor, it is important to check the load duty cycle to avoid overloading the motor during peak-load conditions. This is especially applicable in seasonal industries that experience peak loads only a few times each year. For example, the motor described in Figure 10 operates near full load about 15% of the time. In that case, downsizing the motor could cause overheating, so speed control could be a better solution.

Common Motor Selection Problems

Electric motors are relatively inefficient when they are operated at very light loads, that is, below 40% of the rated load. They are usually most efficient at about 70% to 80% load. A good rule of thumb is to size motors to operate at about 75% load. This will also take into account occasional operational changes that require a higher load; problems such as voltage unbalance that require motor derating; and any errors in the calculation of the motor load.

■ Oversized Motors

Engineers frequently specify motors that are larger than needed to meet system requirements in order to ensure that the existing motor/drive assembly can support anticipated increases in capacity. However, the consequences of oversizing motors include the following:

- Lower efficiency
- Higher motor/controller costs
- Higher installation costs
- Lower power factor
- Increased operating costs.

Motor operation at low **load factor** can result when the driven load is smaller than anticipated. In many applications, original equipment manufacturers will overstate the horsepower needs of their equipment to avoid liability in specifying a motor that cannot meet service requirements. This practice and the tendency of engineers who assemble the system to be conservative can lead to the selection of a motor that operates far below its rated capacity.

■ Poor Power Factor

Another consequence of improper motor selection is low power factor. Power factor is the ratio of real power—the power used to perform mechanical work—to apparent power. In many motors, some of the electrical energy is stored in the magnetic field, creating a time difference between the motor’s peak voltage and its peak current. When current and voltage are out of phase, the amount of real power is less than the amount of electric power available (the scalar product of volts and **amps**) in the line. The vector difference between real power and the product of volts and amps is known as *reactive power*. This relationship is shown in Figure 11.

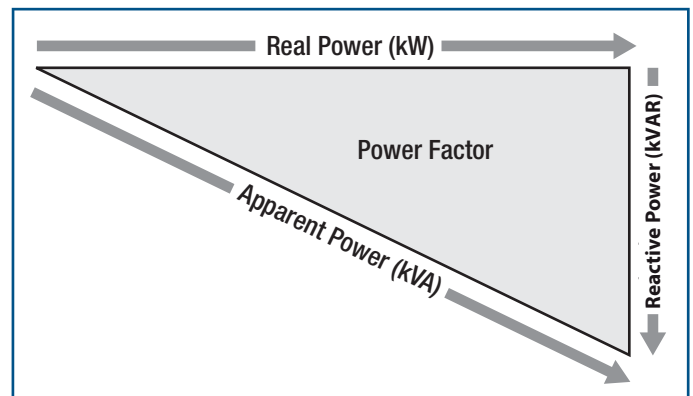

Figure 11. Vector representation of power factor

Reactive power creates additional I^2R losses in the distribution system and creates additional stress on transformers. (I refers to current and R refers to resistance; power lost because of current flow is the product of voltage drop and current; voltage drop in a resistive circuit is the product of current and resistance.) Consequently, utilities often assess fees for reactive power to recover the costs associated with stress on the distribution equipment. Plants that have large motor systems often face substantial power factor penalties; therefore, many facilities invest in **capacitors** to increase their overall power factor and thus minimize these costs.

■ Undersized Motors

Another type of motor selection problem is undersizing the motor for the intended application. Motors should be sized to operate from 75% to 100% of rated load. The principal consequence of operating a motor above its rated load is a higher winding temperature, which shortens the operating life of the motor. If the motor has a service factor of 1.0, the motor lifetime may be only a few months if it is operated above rated load or if it is operated at rated load when there is a power quality problem.

As a rule of thumb, every 10°C rise in winding temperature reduces insulation life by half. Although motor efficiency drops off slightly at higher-than-rated loads, the increase in energy cost is usually not as severe as the cost associated with shorter intervals between repairs or replacements.

Summary

Motor and drive systems can be highly efficient and reliable if they are specified, configured, and maintained properly. However, significant performance improvement opportunities can often be found in systems with poorly sized, ill-configured, or inadequately maintained motors. Often, most of the energy used by the motor systems in an industrial facility is concentrated in a few systems. These systems tend to feature large motors that run much of the time.

Energy-intensive motor and drive systems tend to be critically important to production. So, they might not often be evaluated for efficiency improvements, because then they would have to be shut down for a time for repairs or replacement. However, because of the close relationship between motor efficiency, performance, and reliability, it can be beneficial to implement energy efficiency projects that involve these systems.

Often, the most important benefit of an energy efficiency project is the increased level of motor reliability (i.e., uninterrupted service) that can result. Consequently, engineers, managers, and operators can provide their plants with an important competitive advantage by using a systems approach—one that includes all the benefits of greater system efficiency—to assess their motor and drive applications.